



LP 3140 | 3151

Contents

1	Machine Parts.....	1-1
	Components at the Front of the Printer	1-2
	Components at the Left and the Rear of the Printer	1-3
	Components at the Right of the Printer	1-4
2	Printing Operation.....	2-1
	Loading Printer Driver	2-2
	Printing from Application Software	2-3
3	Maintenance	3-1
	General Information	3-2
	Toner Container Replacement	3-3
	Cleaning the Printer	3-9
4	Troubleshooting.....	4-1
	General Guideline	4-2
	Print Quality Problems	4-4
	Indicators and Messages	4-7
	Correcting a Paper Jam	4-14
5	Specifications.....	5-1

Legal and Safety Information

CAUTION: NO LIABILITY IS ASSUMED FOR ANY DAMAGE CAUSED BY IMPROPER INSTALLATION.

Notice on Software

SOFTWARE USED WITH THIS PRINTER MUST SUPPORT THE PRINTER'S EMULATION MODE. The printer is factory-set to emulate the PCL. The emulation mode can be changed.

Notice

The information in this guide is subject to change without notification. Additional pages may be inserted in future editions. The user is asked to excuse any technical inaccuracies or typographical errors in the present edition.

No responsibility is assumed if accidents occur while the user is following the instructions in this guide. No responsibility is assumed for defects in the printer's firmware (contents of its read-only memory).

This guide, any copyrightable subject matter sold or provided with or in connection with the sale of the page printer, are protected by copyright. All rights are reserved. Copying or other reproduction of all or part of this guide, any copyrightable subject matter without the prior written consent of UTAH GmbH is prohibited. Any copies made of all or part of this guide, any copyrightable subject must contain the same copyright notice as the material from which the copying is done.

Regarding Tradenames

PRESCRIBE is a registered trademark of Kyocera Corporation. KPDL and KIR (Kyocera Image Refinement) are trademarks of Kyocera Corporation.

Hewlett-Packard, PCL, and PJI are registered trademarks of Hewlett-Packard Company. Centronics is a trade name of Centronics Data Computer Inc. PostScript is a registered trademark of Adobe Systems Incorporated. Macintosh is a registered trademark of Apple Computer, Inc. Microsoft, Windows, and Windows NT are registered trademarks of Microsoft Corporation. Microsoft Windows Server is a trademark of Microsoft Corporation. PowerPC is a trademark of International Business Machines Corporation. CompactFlash is a trademark of SanDisk Corporation.

This product uses PeerlessPrintXL to provide the HP LaserJet compatible PCL 6 language emulation. PeerlessPrintXL is a trademark of Peerless Systems Corporation, 2381 Rosecrans Ave. El Segundo, CA 90245, U.S.A.

This product was developed using the Tornado™ Real Time Operating System and Tools from Wind River Systems.

This product contains UFST™ and MicroType® from Monotype Imaging Inc.

USB



This product has been certified by the USB Implementers Forum, Inc.

License Agreements

IBM Program License Agreement

The following information is voluntarily provided in English.

THE DEVICE YOU HAVE PURCHASED CONTAINS ONE OR MORE SOFTWARE PROGRAMS (“PROGRAMS”) WHICH BELONG TO INTERNATIONAL BUSINESS MACHINES CORPORATION (“IBM”). THIS DOCUMENT DEFINES THE TERMS AND CONDITIONS UNDER WHICH THE SOFTWARE IS BEING LICENSED TO YOU BY IBM. IF YOU DO NOT AGREE WITH THE TERMS AND CONDITIONS OF THIS LICENSE, THEN WITHIN 14 DAYS AFTER YOUR ACQUISITION OF THE DEVICE YOU MAY RETURN THE DEVICE FOR A FULL REFUND. IF YOU DO NOT SO RETURN THE DEVICE WITHIN THE 14 DAYS, THEN YOU WILL BE ASSUMED TO HAVE AGREED TO THESE TERMS AND CONDITIONS.

The Programs are licensed not sold. IBM, or the applicable IBM country organization, grants you a license for the Programs only in the country where you acquired the Programs. You obtain no rights other than those granted you under this license.

The term “Programs” means the original and all whole or partial copies of it, including modified copies or portions merged into other programs. IBM retains title to the Programs. IBM owns, or has licensed from the owner, copyrights in the Programs.

1. License

Under this license, you may use the Programs only with the device on which they are installed and transfer possession of the Programs and the device to another party.

If you transfer the Programs, you must transfer a copy of this license and any other documentation to the other party. Your license is then terminated. The other party agrees to these terms and conditions by its first use of the Program.

You may not:

- 1 use, copy, modify, merge, or transfer copies of the Program except as provided in this license;
- 2 reverse assemble or reverse compile the Program; or
- 3 sublicense, rent, lease, or assign the Program.

2. Limited Warranty

The Programs are provided “AS IS.”

THERE ARE NO OTHER WARRANTIES COVERING THE PROGRAMS (OR CONDITIONS), EXPRESS OR IMPLIED, INCLUDING, BUT NOT LIMITED TO, THE IMPLIED WARRANTIES OF MERCHANTABILITY AND FITNESS FOR A PARTICULAR PURPOSE.

Some jurisdictions do not allow the exclusion of implied warranties, so the above exclusion may not apply to you.

3. Limitation of Remedies

IBM's entire liability under this license is the following:

For any claim (including fundamental breach), in any form, related in any way to this license, IBM's liability will be for actual damages only and will be limited to the greater of:

- 1** the equivalent of U.S. \$25,000 in your local currency; or
- 2** IBM's then generally available license fee for the Program

This limitation will not apply to claims for bodily injury or damages to real or tangible personal property for which IBM is legally liable.

IBM will not be liable for any lost profits, lost savings, or any incidental damages or other economic consequential damages, even if IBM, or its authorized supplier, has been advised of the possibility of such damages. IBM will not be liable for any damages claimed by you based on any third party claim. This limitation of remedies also applies to any developer of Programs supplied to IBM. IBM's and the developer's limitations of remedies are not cumulative. Such developer is an intended beneficiary of this Section. Some jurisdictions do not allow these limitations or exclusions, so they may not apply to you.

4. General

You may terminate your license at any time. IBM may terminate your license if you fail to comply with the terms and conditions of this license. In either event, you must destroy all your copies of the Program. You are responsible for payment of any taxes, including personal property taxes, resulting from this license. Neither party may bring an action, regardless of form, more than two years after the cause of action arose. If you acquired the Program in the United States, this license is governed by the laws of the State of New York. If you acquired the Program in Canada, this license is governed by the laws of the Province of Ontario. Otherwise, this license is governed by the laws of the country in which you acquired the Program.

Typeface Trademark Acknowledgement

All resident fonts in this printer are licensed from Monotype Imaging Inc.

Helvetica, Palatino and Times are registered trademarks of Linotype-Hell AG. ITC Avant Garde Gothic, ITC Bookman, ITC ZapfChancery and ITC Zapf Dingbats are registered trademarks of International Typeface Corporation.

Monotype Imaging License Agreement

The following information is voluntarily provided in English.

- 1 "Software" shall mean the digitally encoded, machine readable, scalable outline data as encoded in a special format as well as the UFST Software.
- 2 You agree to accept a non-exclusive license to use the Software to reproduce and display weights, styles and versions of letters, numerals, characters and symbols ("Typefaces") solely for your own customary business or personal purposes at the address stated on the registration card you return to Monotype Imaging. Under the terms of this License Agreement, you have the right to use the Fonts on up to three printers. If you need to have access to the fonts on more than three printers, you need to acquire a multi-user license agreement which can be obtained from Monotype Imaging. Monotype Imaging retains all rights, title and interest to the Software and Typefaces and no rights are granted to you other than a License to use the Software on the terms expressly set forth in this Agreement.
- 3 To protect proprietary rights of Monotype Imaging, you agree to maintain the Software and other proprietary information concerning the Typefaces in strict confidence and to establish reasonable procedures regulating access to and use of the Software and Typefaces.
- 4 You agree not to duplicate or copy the Software or Typefaces, except that you may make one backup copy. You agree that any such copy shall contain the same proprietary notices as those appearing on the original.
- 5 This License shall continue until the last use of the Software and Typefaces, unless sooner terminated. This License may be terminated by Monotype Imaging if you fail to comply with the terms of this License and such failure is not remedied within thirty (30) days after notice from Monotype Imaging. When this License expires or is terminated, you shall either return to Monotype Imaging or destroy all copies of the Software and Typefaces and documentation as requested.
- 6 You agree that you will not modify, alter, disassemble, decrypt, reverse engineer or decompile the Software.

-
- 7** Monotype Imaging warrants that for ninety (90) days after delivery, the Software will perform in accordance with Monotype Imaging-published specifications, and the diskette will be free from defects in material and workmanship. Monotype Imaging does not warrant that the Software is free from all bugs, errors and omissions.
 - 8** THE PARTIES AGREE THAT ALL OTHER WARRANTIES, EXPRESSED OR IMPLIED, INCLUDING WARRANTIES OF FITNESS FOR A PARTICULAR PURPOSE AND MERCHANTABILITY, ARE EXCLUDED.
 - 9** Your exclusive remedy and the sole liability of Monotype Imaging in connection with the Software and Typefaces is repair or replacement of defective parts, upon their return to Monotype Imaging.
 - 10** IN NO EVENT WILL MONOTYPE IMAGING BE LIABLE FOR LOST PROFITS, LOST DATA, OR ANY OTHER INCIDENTAL OR CONSEQUENTIAL DAMAGES, OR ANY DAMAGES CAUSED BY ABUSE OR MISAPPLICATION OF THE SOFTWARE AND TYPEFACES.
 - 11** Massachusetts U.S.A. law governs this Agreement.
 - 12** You shall not sublicense, sell, lease, or otherwise transfer the Software and/or Typefaces without the prior written consent of Monotype Imaging.
 - 13** Use, duplication or disclosure by the Government is subject to restrictions as set forth in the Rights in Technical Data and Computer Software clause at FAR 252-227-7013, subdivision (b)(3)(ii) or subparagraph (c)(1)(ii), as appropriate. Further use, duplication or disclosure is subject to restrictions applicable to restricted rights software as set forth in FAR 52.227-19 (c)(2).
 - 14** YOU ACKNOWLEDGE THAT YOU HAVE READ THIS AGREEMENT, UNDERSTAND IT, AND AGREE TO BE BOUND BY ITS TERMS AND CONDITIONS. NEITHER PARTY SHALL BE BOUND BY ANY STATEMENT OR REPRESENTATION NOT CONTAINED IN THIS AGREEMENT. NO CHANGE IN THIS AGREEMENT IS EFFECTIVE UNLESS WRITTEN AND SIGNED BY PROPERLY AUTHORIZED REPRESENTATIVES OF EACH PARTY. BY OPENING THIS DISKETTE PACKAGE, YOU AGREE TO ACCEPT THE TERMS AND CONDITIONS OF THIS AGREEMENT.

Compliance and Conformity

Safety Information

DANGER: CLASS 3B LASER RADIATION WHEN OPEN. AVOID DIRECT EXPOSURE TO BEAM.

CAUTION: Use of controls or adjustments or performance of procedures other than those specified herein may result in hazardous radiation exposure.

Radio Frequency Transmitter

This machine contains the transmitter module. We, the manufacturer (UTAX GmbH) hereby declare that this equipment (page printer), model LP 3140 and LP 3151 are in compliance with the essential requirements and other relevant provisions of Directive 1999/5/EC.

Radio Tag Technology

In some countries the radio tag technology used in this equipment to identify the toner container may be subject to authorization and the use of this equipment may consequently be restricted.

Caution Labels

Caution labels have been attached to the copier at the following locations for safety purposes. Be sufficiently careful to avoid fire or electric shock when removing a paper jam or when replacing toner.

NOTE: Do not remove these labels.

 CAUTION EXTREMELY HOT SURFACE Avoid contact.	ATTENTION SURFACE TRÈS CHAUDE	VORSICHT SEHR HEISSE OBERFLÄCHE	PRECAUCION SUPERFICIE SUMAMENTE CALENTE	CAUTELA SUPERFICIE ESTREMAMENTE CALDA Evitare il contatto.	ВНИМАНИЕ Поверхность очень горячая. Не дотрагиваться.	注意 表面炽熱、 避免觸碰。	注意 表面燒熱、 避免觸碰。	
---	--	--	--	---	--	-----------------------------	-----------------------------	---

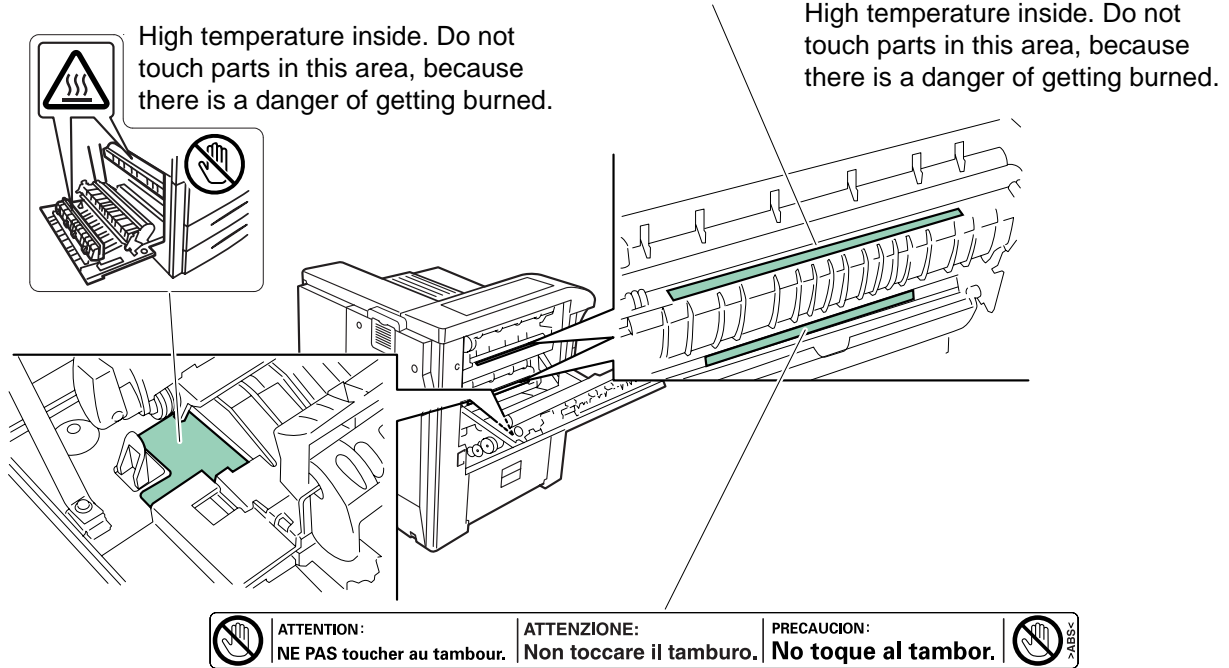

Do not incinerate toner and toner container.
Dangerous sparks may cause burn.

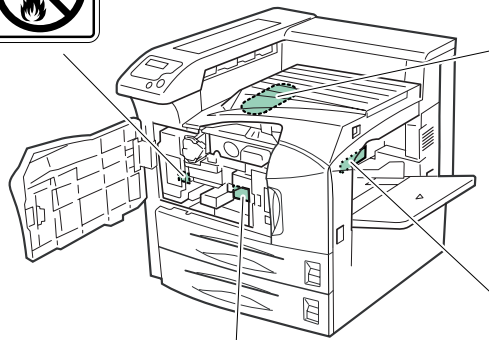

← DANGER
LASER RADIATION WHEN
DEVELOPER UNIT IS
REMOVED. AVOID DIRECT
EXPOSURE TO BEAM.

Label inside the printer (Laser
radiation warning)

DANGER	· LASER RADIATION WHEN OPEN. AVOID DIRECT EXPOSURE TO BEAM.
ATTENTION	· RAYONNEMENT LASER EN CAS D'OUVERTURE. EXPOSITION DANGEREUSE AU FASCICEL.
VORSICHT	· LASERSTRAHLUNG, WENN ABDECKUNG GEOFFNET. NICHT DEM STRAHL AUSSETZEN.
ATTENZIONE	· RADIAZIONE LASER IN CASO DI APERTURA. EVITARE L'ESPOSIZIONE AL FASCIO.
PRECAUCION	· RADIAZIONE LASER CUANDO SE ABRE. EVITAR EXPONERSE AL RAYO.
VARO!	· AVATTAESSA OLET ALTTIINA LASERSÄTEILYLLE. ÄLÄ KATSO SÄTEESEEN. 警告・この()の部分ではレーザー光が照射されています。 レコーダー前にさされぬようご注意ください。 警告・开蓋時、可能有激光外泄！应避免激光直接照射。 警告・内部照射放射中、請勿隨意打開蓋子。



Moving parts inside. May cause
personal injury. Do not touch
moving parts.

For Europe, Asia,
and other countries

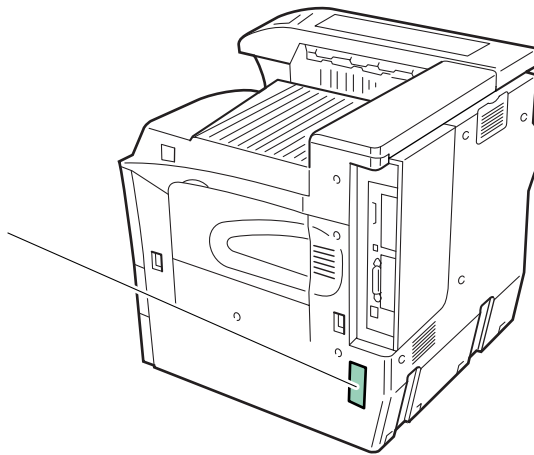

Ozone Concentration

The printers generate ozone gas (O₃) which may concentrate in the place of installation and cause an unpleasant smell. To minimize the concentration of ozone gas to less than 0.1ppm, we recommend you not to install the printer in a confined area where ventilation is blocked.

CE Marking Directive

According to Council Directive 89/336/EEC, 73/23/EEC, and 1999/5/EC

Manufacturer: UTAx GmbH

Manufacturer's address: Ohechaussee 235, 22848 Norderstedt

Declares that the product

Product name: Page Printer

Model number: LP 3140/3151 (as tested with enhancement optional unit; Dual Paper Feeder PF-700, Large Capacity Paper Feeder PF-750, Document Finisher DF-710/DF-730, Booklet Unit BF-710, Mail Bin MT-710, and Punch Unit PH-5A)

Conforms to the following product specifications:

EN 55 022:1998+A1:2000+A2:2003 Class B

EN 61 000-3-2:2000

EN 61 000-3-3:1995+A1:2001

EN 55 024:1998+A1:2001+A2:2003

EN 60 950-1:2001+A11

EN 60 825-1:1994+A1+A2

EN 300330-1

EN 300330-2

The manufacturer and its merchandising companies retain the following technical documentation in anticipation of the inspection that may be conducted by the authorities concerned.

User's instruction that conforms to the applicable specifications.

Technical drawings.

Descriptions of procedures that guarantee conformity.

Other technical information.

EN ISO 7779

Maschinenlärminformations-Verordnung 3. GPSGV, der höchste Schalldruckpegel beträgt 70 dB (A) oder weniger gemäß EN ISO 7779.

Disclaimer

UTAX GmbH will not be liable to customers or any other person or entity for any loss or damage caused or alleged to be caused directly or indirectly by equipment sold or furnished by us, including but not limited to, any interruption of service, loss of business or anticipatory profits, or consequential damages resulting from the use or operation of the equipment or software.

This printer is equipped with a sleep timer function. This function makes it possible to reduce the amount of electrical power consumed by the printer. For maximum power savings, turn off the printer's power supply when not using the printer for extended periods of time.

For details on the sleep timer function and printer power consumption, refer to this manual.

Initial settings of the sleep timer function and power saved using the sleep timer function:

	LP 3140	LP 3151
Initial Auto Sleep Setting	15 minutes (60 minutes)	15 minutes (60 minutes)
Power Consumption in Auto Sleep	4.5W (40W)	4.5W (75W)

Please read this Operation Guide before using the machine. Keep it close to the machine for easy reference.

The sections of this guide and parts of the machine marked with symbols are safety warnings meant to protect the user, other individuals and surrounding objects, and ensure correct and safe usage of the machine. The symbols and their meanings are indicated below.



DANGER: Indicates that serious injury or even death will very possibly result from insufficient attention to or incorrect compliance with the related points.



WARNING: Indicates that serious injury or even death may result from insufficient attention to or incorrect compliance with the related points.



CAUTION: Indicates that personal injury or mechanical damage may result from insufficient attention to or incorrect compliance with the related points.

Symbols

The following symbols indicate that the related section includes safety warnings. Specific points of attention are indicated inside the symbol.



.... [General warning]



.... [Warning of danger of electrical shock]



.... [Warning of high temperature]

The following symbols indicate that the related section includes information on prohibited actions. Specifics of the prohibited action are indicated inside the symbol.



.... [Warning of prohibited action]



.... [Disassembly prohibited]

The following symbols indicate that the related section includes information on actions which must be performed. Specifics of the required action are indicated inside the symbol.



.... [Alert of required action]



.... [Remove the power plug from the outlet]



.... [Always connect the machine to an outlet with a ground connection]

Please contact your service representative to order a replacement if the safety warnings in this Operation Guide are illegible or if the guide itself is missing. (fee required)



Installation Precautions

Environment



CAUTION:

Avoid placing the machine on or in locations which are unstable or not level. Such locations may cause the machine to fall down or fall over. This type of situation presents a danger of personal injury or damage to the machine.



Avoid locations with humidity or dust and dirt. If dust or dirt become attached to the power plug, clean the plug to avoid the danger of fire or electrical shock.



Avoid locations near radiators, heaters, or other heat sources, or locations near flammable items, to avoid the danger of fire.



To keep the machine cool and facilitate changing of parts and maintenance, allow access space as shown below. Leave adequate space, especially around the vents, to allow air to be properly ventilated out of the printer.

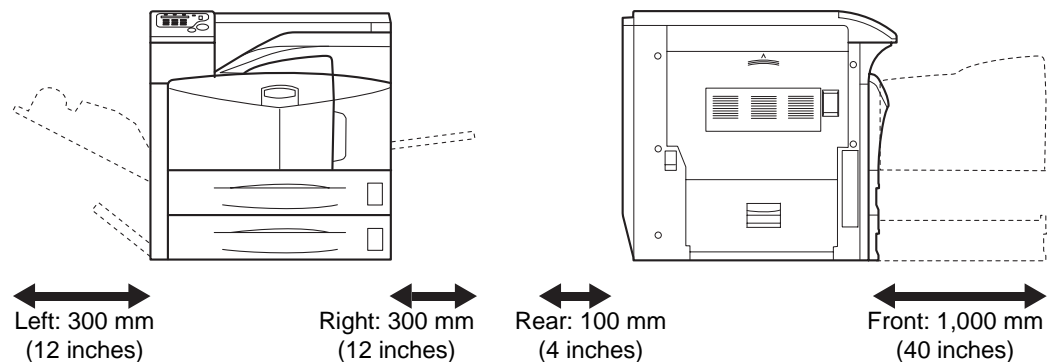

Always use the caster stoppers to stabilize the printer once it is in place to keep it from moving and/or falling over and causing injury.



Other Precautions

Adverse environmental conditions may affect the safe operation and performance of the machine. Install in an air-conditioned room (recommended room temperature: around 23°C, humidity: around 60% RH), and avoid the following locations when selecting a site for the machine.

- Avoid locations near a window or with exposure to direct sunlight.
- Avoid locations with vibrations.
- Avoid locations with drastic temperature fluctuations.
- Avoid locations with direct exposure to hot or cold air.
- Avoid poorly ventilated locations.
- When casters are installed on the printer, moving the printer can cause damage to certain floor surfaces.

During printing, some ozone is released, but the amount does not cause any ill effect to one's health. If, however, the printer is used over a long period of time in a poorly ventilated room or when printing an extremely large number of copies, the smell may become unpleasant. To maintain the appropriate environment for print work, it is suggested that the room be properly ventilated.

Power Supply/Grounding the Machine



WARNING:

Do not use a power supply with a voltage other than that specified. Avoid multiple connections in the same outlet. These types of situations present a danger of fire or electrical shock.



Plug the power cord securely into the outlet. If metallic objects come in contact with the prongs on the plug, it may cause a fire or electric shock.



Always connect the machine to an outlet with a ground connection to avoid the danger of fire or electrical shock in case of an electric short. If an earth connection is not possible, contact your service representative.



Other Precautions

Connect the power plug to the closest outlet possible to the machine.

The power supply cord is used as the main disconnect device. Ensure that the socket/outlet is located/installed near the equipment and is easily accessible.

Handling of Plastic Bags



WARNING:

Keep the plastic bags that are used with the machine away from children. The plastic may cling to their nose and mouth causing suffocation.





Precautions for Use

Cautions when Using the Machine



WARNING:

Do not place metallic objects or containers with water (flower vases, flower pots, cups, etc.) on or near the machine. This situation presents a danger of fire or electrical shock should they fall inside.



Do not remove any of the covers from the machine as there is a danger of electrical shock from high voltage parts inside the machine.



Do not damage, break or attempt to repair the power cord. Do not place heavy objects on the cord, pull it, bend it unnecessarily or cause any other type of damage. These types of situations present a danger of fire or electrical shock.



Never attempt to repair or disassemble the machine or its parts as there is a danger of fire, electrical shock or damage to the laser. If the laser beam escapes, there is a danger of it causing blindness.



If the machine becomes excessively hot, smoke appears from the machine, there is an odd smell, or any other abnormal situation occurs, there is a danger of fire or electrical shock. Turn the power switch off (O) immediately, be absolutely certain to remove the power plug from the outlet and then contact your service representative.



If anything harmful (paper clips, water, other fluids, etc.) falls into the machine, turn the power switch off (O) immediately. Next, be absolutely certain to remove the power plug from the outlet to avoid the danger of fire or electrical shock. Then contact your service representative.



Do not remove or connect the power plug with wet hands, as there is a danger of electrical shock.



Always contact your service representative for maintenance or repair of internal parts.





CAUTION:

Do not pull the power cord when removing it from the outlet. If the power cord is pulled, the wires may become broken and there is a danger of fire or electrical shock. (Always grasp the power plug when removing the power cord from the outlet.)

Always remove the power plug from the outlet when moving the machine. If the power cord is damaged, there is a danger of fire or electrical shock.



If the machine will not be used for a short period of time (overnight, etc.), turn the power switch off (O). If it will not be used for an extended period of time (vacations, etc.), remove the power plug from the outlet for safety purposes during the time the machine is not in use.



When lifting or moving the printer, pull up the 4 handles on both sides of the printer, then ALWAYS carry the printer by the designated 4 handles with at least 4 people, one person to a handle.



For safety purposes, always remove the power plug from the outlet when performing cleaning operations.



If dust accumulates within the machine, there is a danger of fire or other trouble. It is therefore recommended that you consult with your service representative in regard to cleaning of internal parts. This is particularly effective if accomplished prior to seasons of high humidity. Consult with your service representative in regard to the cost of cleaning the internal parts of the machine.



Other Precautions

Do not place heavy objects on the machine or cause other damage to the machine.

Do not open the upper front cover, turn off the power switch, or pull out the power plug during printing.

When lifting or moving the machine, contact your service representative.

Do not touch electrical parts, such as connectors or printed circuit boards. They could be damaged by static electricity.

Do not attempt to perform any operations not explained in this handbook.

Use shielded interface cables.



CAUTION:

Use of controls or adjustments or performance of procedures other than those specified herein may result in hazardous radiation exposure.

Cautions when Handling Consumables



CAUTION:

Do not attempt to incinerate the Toner Container. Dangerous sparks may cause burns.



Never open the toner container or waste toner box.



Keep the Toner Container out of the reach of children.



If toner happens to spill from the Toner Container, avoid inhalation and ingestion, as well as contact with your eyes and skin.



- If you do happen to inhale toner, move to a place with fresh air and gargle thoroughly with a large amount of water. If coughing develops, contact a physician.
- If you do happen to ingest toner, rinse your mouth out with water and drink 1 or 2 cups of water to dilute the contents of your stomach. If necessary, contact a physician.
- If you do happen to get toner in your eyes, flush them thoroughly with water. If there is any remaining tenderness, contact a physician.
- If toner does happen to get on your skin, wash with soap and water.

Do not attempt to force open or destroy the Toner Container.



Other Precautions

After use, always dispose of the Toner Container in accordance with Federal, State and Local rules and regulations.

Store all consumables in a cool, dark location.

If the machine will not be used for an extended period of time, remove the paper from the cassette, return it to its original package and reseal it.

Guide to the Operation Guide

This Operation Guide has the following chapters:

1 Machine Parts

This chapter explains the names of parts.

2 Printing Operation

This chapter explains how to print from your workstation.

3 Maintenance

This chapter explains how to replace the toner container, waste toner box, and how to care for your printer.

4 Troubleshooting

This chapter explains how to handle printer problems that may occur, such as paper jams.

5 Specifications

Conventions

This manual uses the following conventions:

Convention	Description	Example
Italic Typeface	Used to emphasize a key word, phrase or references to additional information.	Close the <i>top cover</i> . Refer to <i>Toner Container Replacement</i> on page 3-3.
Courier Typeface	Used to denote messages or names displayed on the operation panel.	Replace the waste toner box when the <code>Check waste toner box</code> message is displayed.
Bracket Bold Text Typeface	Used to denote operation panel keys.	Press [Go] .
Bold Typeface	Used to emphasize button or items to be selected in dialog boxes, and titles displaying in dialog boxes.	Click Next .
Notes	Used to provide additional or useful information about a function or feature.	NOTE: For information about storing the pin, refer to step 10.
Important	Used to provide important information.	IMPORTANT: Ensure paper is not folded, curled, or damaged.
Caution	Cautions are statements that suggest <i>mechanical</i> damage as a result of an action.	CAUTION: Do not pull the cassette out when holding the front of the machine.
Warning	Used to alert users to the possibility of <i>personal</i> injury.	WARNING: High voltage is present in the charger section.

1 Machine Parts

This section provides explanations and illustrations for you to determine the parts and their functions. Try to be familiar with the names and functions of these parts for correct use and optimal performance.

This chapter contains explanations on the following topics:

- Components at the Front of the Printer 1-2
- Components at the Left and the Rear of the Printer.... 1-3
- Components at the Right of the Printer 1-4

Components at the Front of the Printer

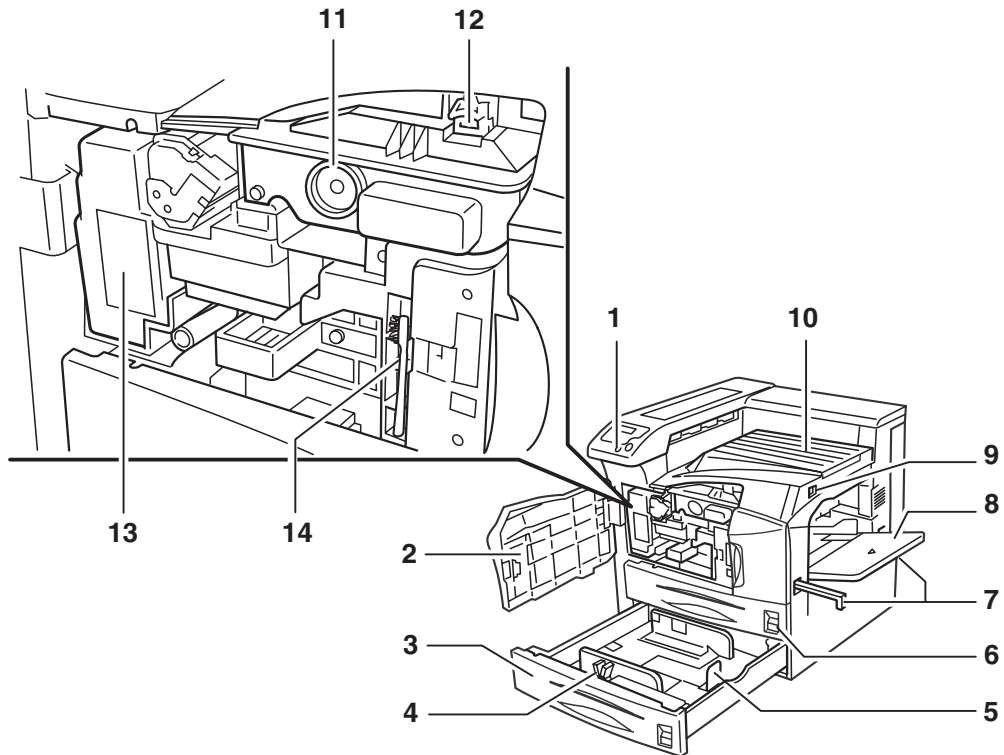

- 1 Operation Panel
- 2 Front Cover
- 3 Paper Cassette 2
- 4 Paper Guide
- 5 Paper Stopper
- 6 Paper Cassette 1
- 7 Handles for Transport
- 8 MP (Multi-Purpose) Tray
- 9 Main Switch
- 10 Top Tray
- 11 Toner Container
- 12 Toner Container Release Lever
- 13 Waste Toner Box
- 14 Cleaning Brush

IMPORTANT: After you turned the printer off, you have to pause five or more seconds to turn it on again.

Components at the Left and the Rear of the Printer

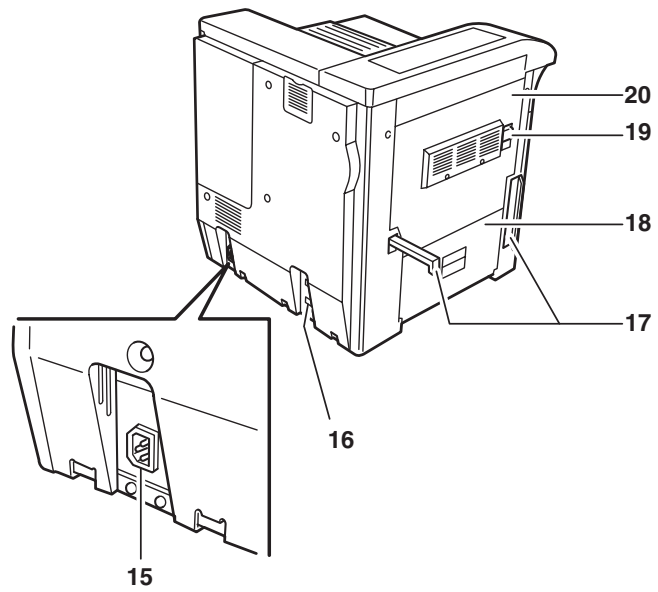

- 15 Power Cord Connector**
- 16 Option Unit Connector**
- 17 Handles for Transport**
- 18 Left Cover 2**
- 19 Lock Lever**
- 20 Left Cover 1**

Components at the Right of the Printer

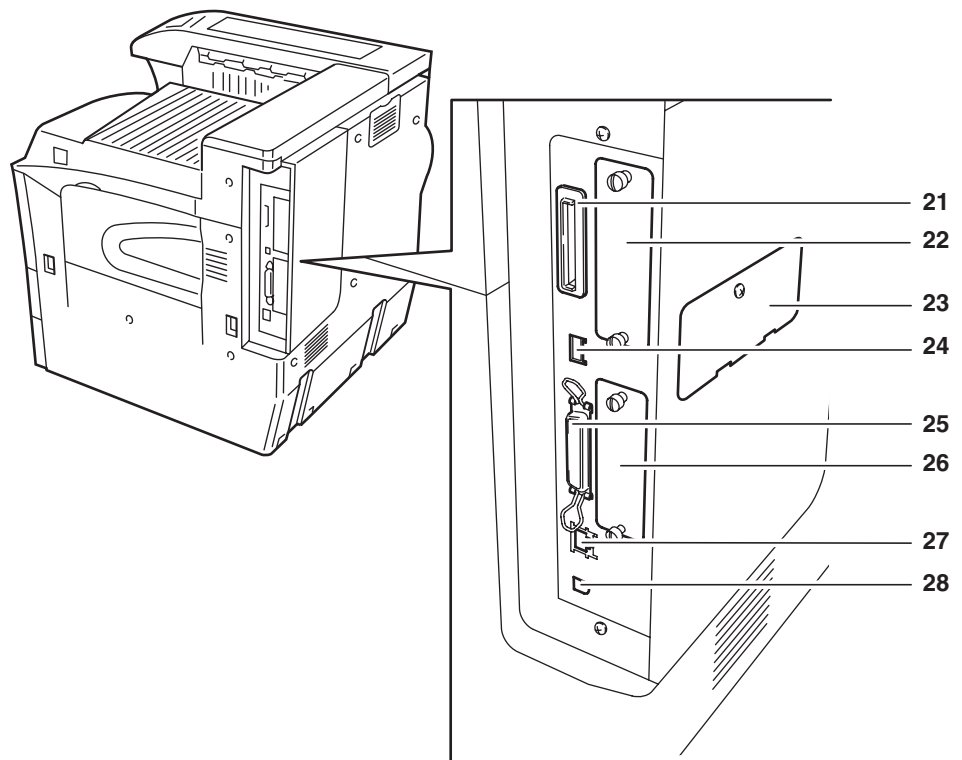

- 21 Memory Card Slot**
- 22 Option Interface Slot (OPT)**
- 23 Option Memory Slot Cover**
- 24 USB Memory Slot (A1)**
- 25 Parallel Interface Connector**
- 26 Option Hard Disk Unit Slot (HDD)**
- 27 Network Interface Connector**
- 28 USB Interface Connector (B1)**

2 Printing Operation

This chapter contains explanations on the following topics:

- Loading Printer Driver 2-2
- Printing from Application Software 2-3

Loading Printer Driver

Ensure the printer is plugged in and connected to the PC before installing the printer driver from the CD-ROM.

- 1 Switch on the PC and activate Windows.

NOTE: If the **Welcome to the Found New Hardware Wizard** dialog box displays, select Cancel.

- 2 Insert the CD-ROM supplied with the printer into the optical drive of the PC.

- 3 The installation program launches.

NOTE: If the installation program fails to launch, use Windows Explorer to access the CD-ROM and select Setup.exe.

- 4 Perform the procedures displayed on the installation program to install the KX DRIVER.

Printing from Application Software

The steps required to print a document created with an application are explained below. You can select the printing *Paper Size* and *Output Destination*.

- 1 Load the paper required into the paper cassette.
- 2 From the application *File* menu, select **Print**. The **Print** dialog box displays.
- 3 Click the drop down list of printer names. All the printers installed in Windows are listed. Click the name of the machine.
- 4 Use **Number of copies** to enter the number of prints required. Up to 999 copies can be entered.

For Microsoft Word, we recommend that you click **Options** and specify **Use printer settings** for the **Default tray**.

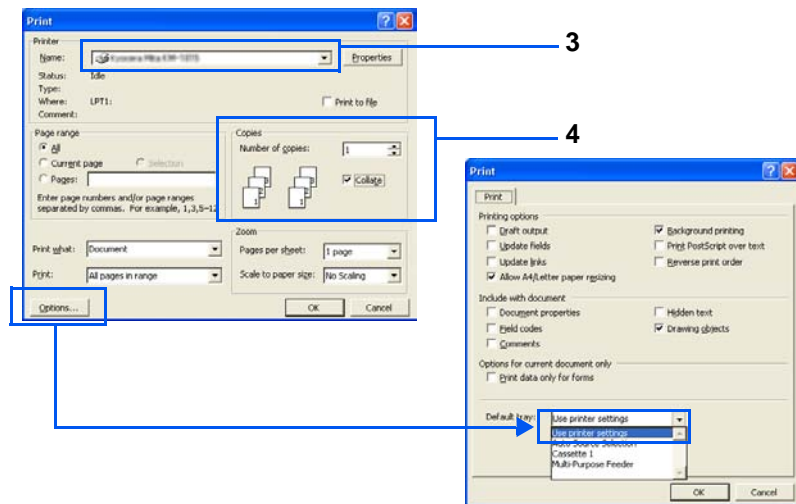

- 5 To start printing, click **OK**.

3 Maintenance

This chapter contains explanations on the following topics:

- General Information..... 3-2
- Toner Container Replacement..... 3-3
- Cleaning the Printer..... 3-9

General Information

This chapter describes basic maintenance tasks you can perform on the printer. You can replace the following component according to the printer's display:

- Toner Container
- Waste Toner Box

Also, the internal parts need periodic cleaning.

Toner Container Replacement

The toner container in the printer should be replaced as soon as the message display shows `Toner low` or soon after. If you continue to use the printer, eventually the toner supply will be exhausted at which point the printer will stop printing and the `Replace toner Clean printer` message will be shown instructing you to install a new toner kit.

Frequency of toner container replacement

Assuming an average toner coverage of 5 % and EcoPrint mode turned off, the toner container will need replacing approximately once every 40,000 pages.

Starter Toner Container

The toner container packed with the new printer is a starter toner container. The starter toner container lasts an average of 20,000 pages.

Toner Kits

For best results, we recommend that you only use genuine Parts and Supplies.

A new toner kit contains the following items:

- Toner Container
- Cleaning cloth
- Plastic waste bags for old toner container and old waste toner box
- Waste toner box

NOTE: Be sure to clean the inside of the printer when replacing the toner container.

Understanding Messages Requesting Toner Container Replacement

The printer displays messages at two stages of toner usage. This message is automatically alternated with the other printer message (such as `Ready`):

- When the printer becomes low on toner, the printer displays the message `Toner low` as the first caution. Note the replacement is not always necessary at this stage.
- If you ignore the above message and continue printing, the printer displays the message `Replace toner` - just before the toner is used up. The toner container must be replaced immediately. After the cleaning is finished, however, the message does not automatically change to `Ready`. To restart printing, you must press **[GO]** and make the printer ready.

Replenishing Toner

This section explains how to replace the toner container. When replacing the toner container, always replace the waste toner box at the same time. If this box is full, the printer may be damaged or contaminated by the waste toner that may spill over the box.

NOTE: During toner container replacement, temporarily put storage media and computer supplies (such as floppy disks) away from around the toner container. This is to avoid damaging media by the magnetism of toner.

You do not have to turn printer power off before starting the replacement. Any data that may be under printing process in the printer will be deleted if you turn printer power off.

- 1 Open the printer front cover all the way.

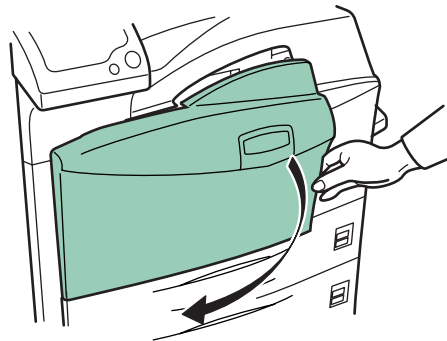

- 2 Push the lock lever up and gently remove the toner container until its handle appears.

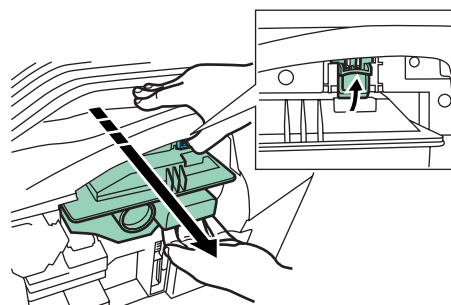

NOTE: Do not pull the toner container all the way as it can fall off and the toner spots the floor.

- 3 Grasp the handle on the toner container, push the lock lever up again and gently lift the toner container.

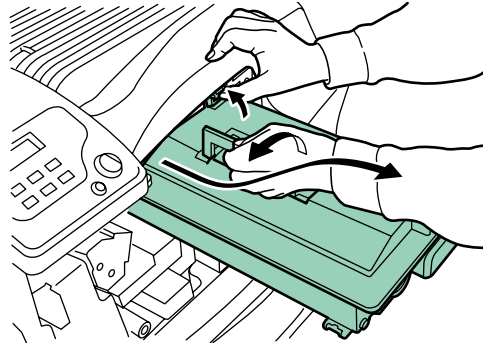

- 4 Seal up the old toner container with the supplied plastic bag and dispose of it.

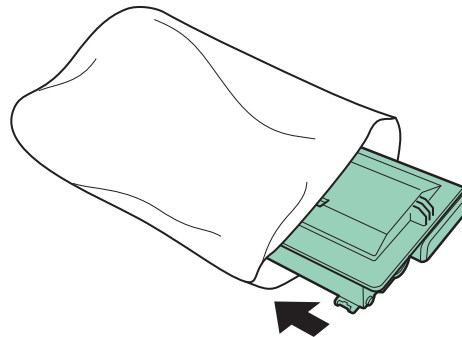

- 5 Lightly tap the new toner on the top 5 to 6 times.

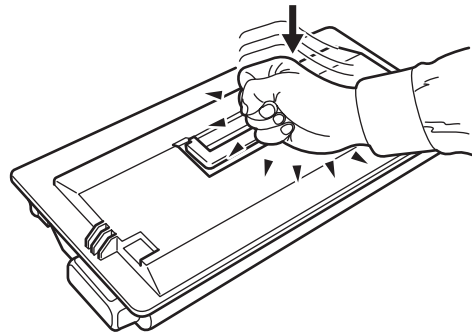

- 6 Thoroughly shake the toner container (in the direction of the arrows) ten times or more to loosen and mix the toner inside.

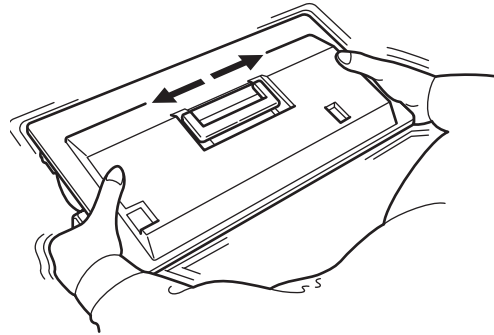

- 7 Grasp the handle on the toner container and insert the toner container along the rail of the printer.

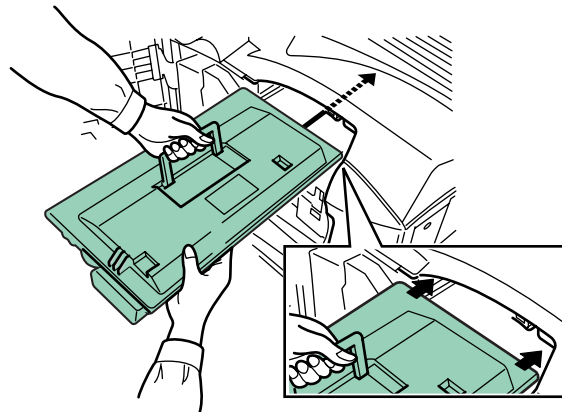

When inserting, be sure that the gear side of the toner container faces the printer. Leave the front cover open to allow insertion of the waste toner box.

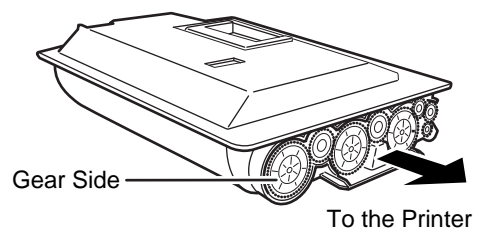

- 8 Hold the toner container using both hands and fully insert it into the printer.

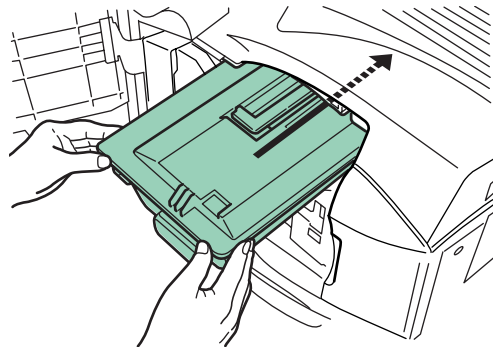

- 9 Close the front cover.

Replacing the Waste Toner Box

When replacing the toner container, the used waste toner box in the printer should also be replaced with the new one from the new toner kit. The printer will not operate without replacing the waste toner box.

- 1 Open the printer front cover all the way.

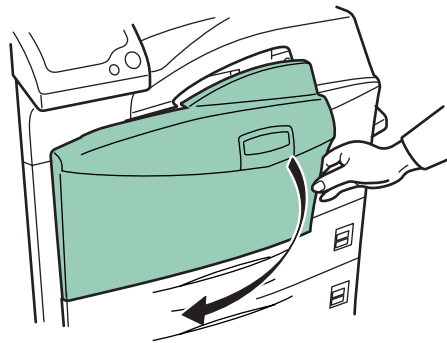

- 2 Remove the old waste toner box as shown in the figure.

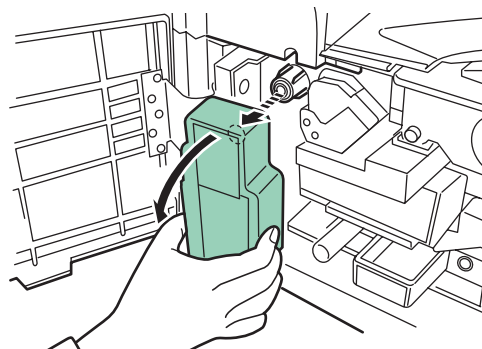

- 3** Remove the seal from the rear of the old waste toner box, and then close the opening of the box with the seal. Seal up the old waste toner box with the supplied plastic bag and dispose of it.

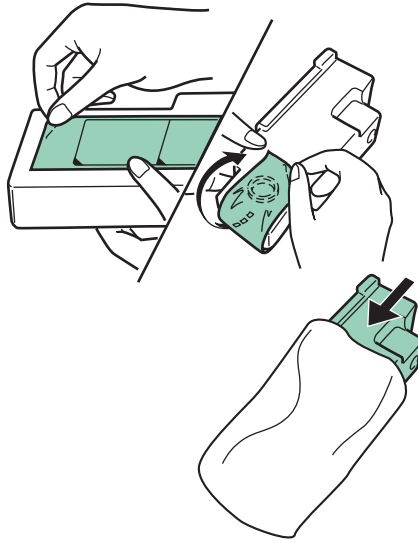

- 4** Fit the new waste toner box to the printer.

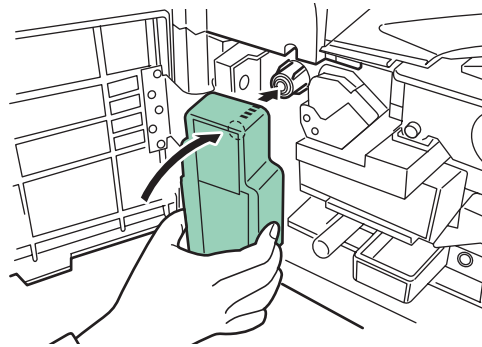

- 5** Close the front cover.

Cleaning the Printer

Cleaning the Filters

When replacing the toner container, also clean the filters.

- 1 Open the MP tray.

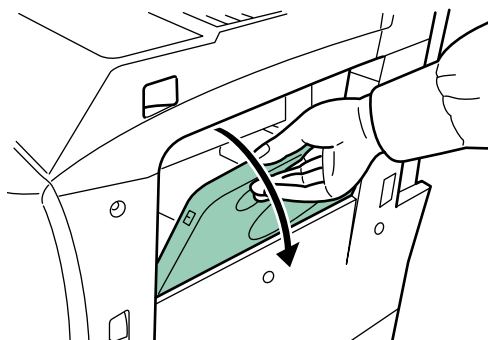

- 2 Remove the filters from the printer. Press in the tabs on the top filter while removing it.

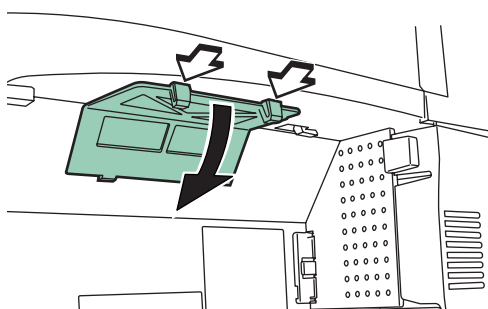

- 3 Press in the tab on the right filter while removing it.

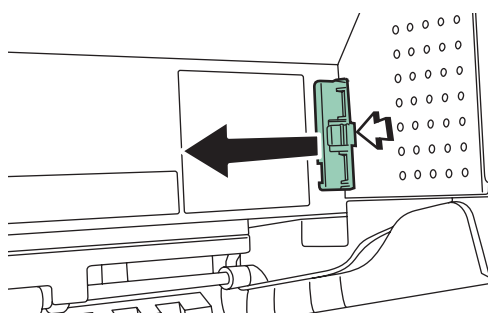

- 4 Clean the filters with a vacuum cleaner.

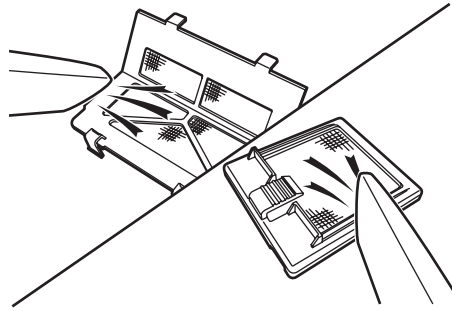

Do not wash the filters nor use the cleaning brush supplied with the machine.

- 5 After cleaning, replace the filters in their original positions.

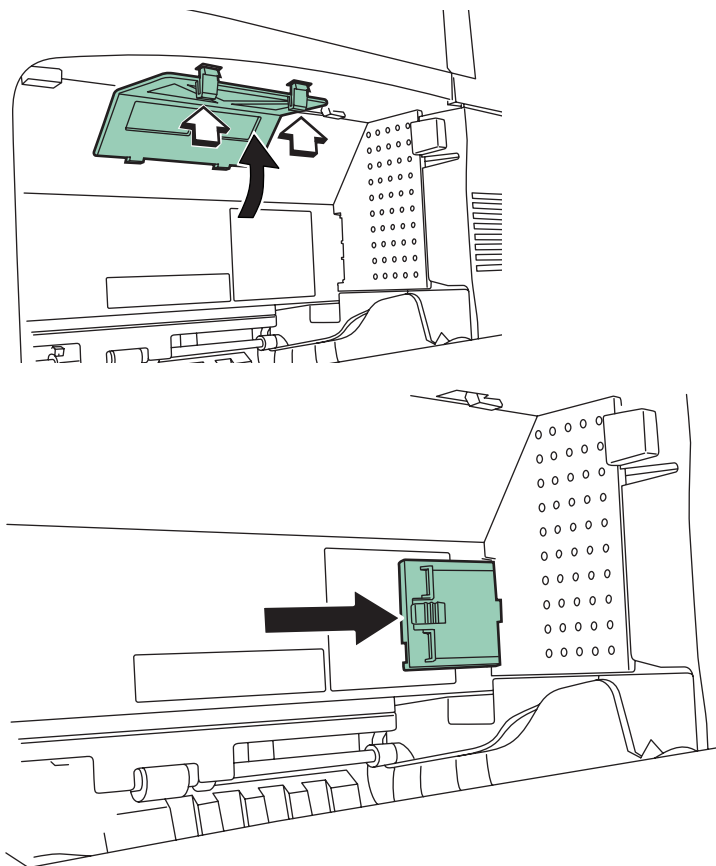

After cleaning the filters, proceed to next section.

The Inside of the Printer

To avoid print quality problems, the interior of the printer must be cleaned.

- 1 Open the front cover all the way.

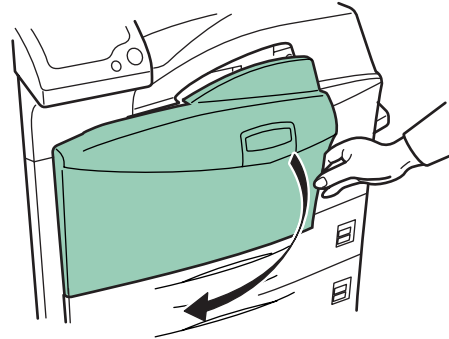

- 2 Remove the blue colored cleaning brush.

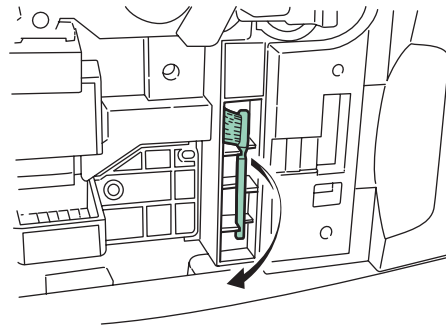

- 3 Pull up the lock lever on the left side of the printer, and open the left cover 1.

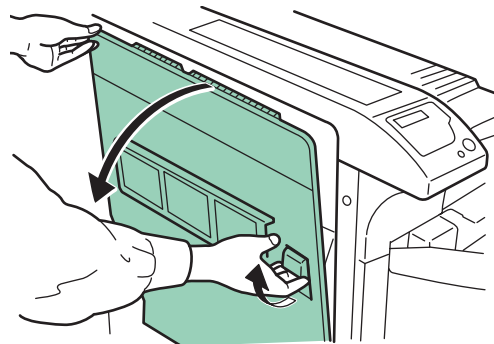

- 4 Clean the separator by moving the cleaning brush from left to right along with the separator.

NOTE: When removing jammed paper, be careful not to touch the printer drum. This can cause printer malfunction.

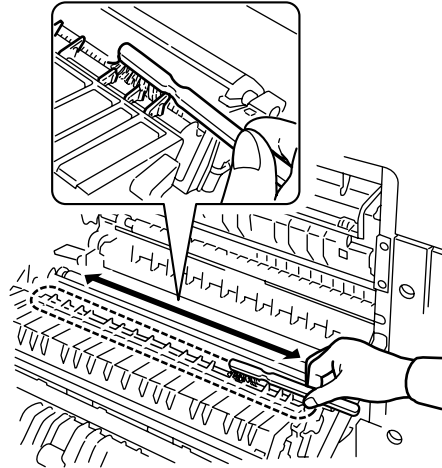

- 5 While rotating the transfer roller with the gear on its left, move the cleaning brush back and forth along the transfer roller to remove soiling as shown. After cleaning, return the cleaning brush to its storage space, and close the left cover 1 and the front cover.

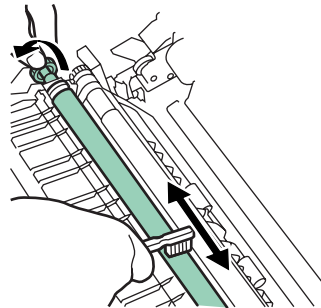

4 Troubleshooting

This chapter explains how to handle printer problems that may occur. If a problem cannot be corrected, contact your service representative.

This chapter explains the following topics:

- General Guideline 4-2
- Print Quality Problems..... 4-4
- Indicators and Messages 4-7
- Correcting a Paper Jam 4-14

General Guideline

If some kind of problem should occur, check the following before concluding the printer is broken;

Symptom	Check Items		Corrective Action
The printer will not print from the computer.	Check the READY indicator.	Off	Look through the items below and check anything that seems appropriate.
		Flashing	An error has occurred. Check the message display, and then take measures referring to <i>Indicators and Messages on page 4-7</i> .
		Lit	Refer to the appropriate item below.
	Check the ATTENTION indicator.	Flashing	Refer to <i>Indicators on page 4-7</i> .
		Lit	
A maintenance message appears in the message display.		Refer to <i>Maintenance Messages on page 4-7</i> .	
Print quality is not good.			Clean the filters. Refer to <i>Print Quality Problems on page 4-4</i> .
Paper is jammed.			Refer to <i>Correcting a Paper Jam on page 4-14</i> .
Nothing lights on the operation panel even when power is turned on and the fan makes no noise.	Check that the power cord is properly plugged into the power outlet.		Turn off the printer's power, plug in the power cord securely, and try turning on the printer's power again.
	Check that the main switch is really in the ON () position.		
The printer prints a status page, but data from the computer is not being printed normally.	Check the interface cable.		Connect both ends of the interface cable securely. Try replacing the printer cable.
	Check program files and application software.		Try printing another file or using another print command. If the problem occurs only with a specific file or application, check the printer settings for that application.

Tips

Printer problems may be solved easily by following the tips below. When you have encountered a problem that following the above guidelines will not solve, try the following:



- Turn the printer power off and wait for several seconds. Then, turn on the printer.
- Reboot the computer which sends the print jobs to the printer.
- Obtain and use the latest version of the printer driver. The latest versions of printer drivers and utilities are available at: <http://www.utax.com/download/>.
- Make sure that the procedures for printing are correctly followed in the application software. Consult the documentation supplied with the application software.
- If the printer prints garbage characters or stalls when the computer is turned on, particularly when the printer is connected to the computer under Windows 98 via the parallel port, rename device driver file `drvppqt.vxd`. This file may be located in `Windows\System\losubsys` or `Arcada\System` folder. For technical details, visit Microsoft web site for the device driver.

Print Quality Problems

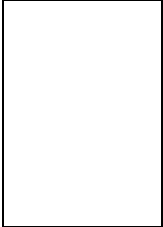
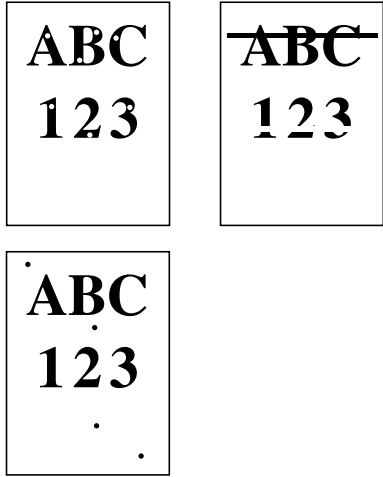
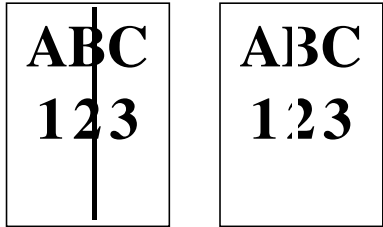
As the following table shows, there are many possible causes of print quality problems, such as blank output. The troubleshooting procedure for each type of problem is explained below. If you still cannot solve the problem, contact your service representative.

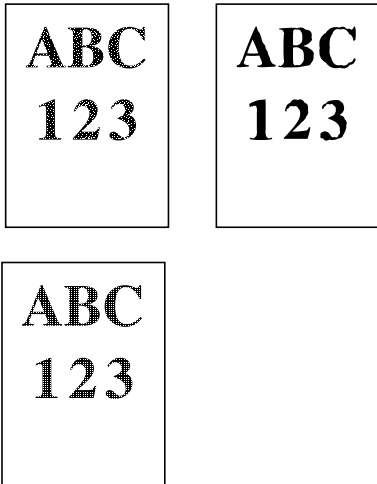
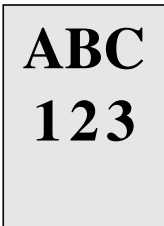
Printed Results	Corrective Action
<p>Completely blank printout</p> 	<p>Check the toner container. Open the printer front cover and check that the toner container is correctly installed in the printer. Refer to <i>Toner Container Replacement</i> on page 3-3.</p>
<p>Dropouts, horizontal streaks, stray dots</p> 	<p>Refresh drum. Refer to the following procedures in the operation panel and try cleaning the drum surface using the printer's built-in cleaning system.</p> <ol style="list-style-type: none"> 1 Press [MENU], and then press Δ or ∇ to display Others >. 2 Press \triangleright, and then press Δ or ∇ to display >Service >. 3 Press \triangleright, and then press Δ or ∇ to display >>Drum. And then press [OK] twice. 4 The message display shows <i>Processing</i>, and then the drum starts turning and stops after approx.6 minutes. The printer reverts to <i>Ready</i>. <p>Clean the separator. Open the printer left cover 1 and clean the separator with a cleaning brush. Refer to <i>Toner Container Replacement</i> on page 3-3.</p>
<p>Black or white vertical streaks</p> 	<p>Clean the charger. Refer to the following procedures in the operation panel and try cleaning the charger using the printer's built-in cleaning system.</p> <ol style="list-style-type: none"> 1 Press [MENU], and then press Δ or ∇ to display Others >. 2 Press \triangleright, and then press Δ or ∇ to display >Service >. 3 Press \triangleright, and then press Δ or ∇ to display >>Charger. And then press [OK] twice. 4 The message display shows <i>Please wait</i>, and then the charger cleaning starts and stops after approx.45 seconds. The printer reverts to <i>Ready</i>.

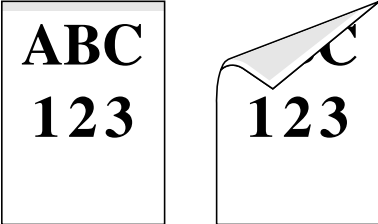
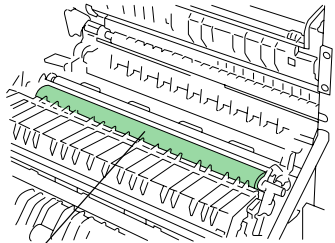

Printed Results	Corrective Action
<p>Faint or blurred printing</p> 	<p>Check the EcoPrint setting. When this setting is On, switch it to Off on the operation panel.</p> <p>Check the operation panel.</p> <ul style="list-style-type: none"> • If the Toner low message is displayed and the ATTENTION indicator is flashing, install a new toner kit. Refer to <i>Toner Container Replacement on page 3-3</i>. • Set the print density from the operation panel to a higher level than the current setting. • Make sure the paper type setting is correct.
<p>Grey background</p> 	<p>Refresh drum. Refer to the following procedures in the operation panel and try cleaning the drum surface using the printer's built-in cleaning system.</p> <ol style="list-style-type: none"> 1 Press [MENU], and then press Δ or ∇ to display Others >. 2 Press \triangleright, and then press Δ or ∇ to display >Service >. 3 Press \triangleright, and then press Δ or ∇ to display >>Drum. And then press [OK] twice. 4 The message display shows Processing, and then the drum starts turning and stops after approx.6 minutes. The printer reverts to Ready. <p>Check the operation panel. If the Toner low message is displayed and the ATTENTION indicator is flashing, install a new toner kit. Refer to <i>Toner Container Replacement on page 3-3</i>.</p> <p>Check the print density. Display the print density menu from the operation panel and select a lighter density setting.</p> <p>Check the toner container installation. Open the printer front cover and check that the toner container is correctly installed. Refer to <i>Toner Container Replacement on page 3-3</i>.</p>

Printed Results	Corrective Action
<p data-bbox="161 264 643 293">Dirt on the top edge or back of the paper</p> <div data-bbox="164 324 544 546">  </div>	<p data-bbox="748 264 1038 293">Check the paper ramp.</p> <p data-bbox="748 304 1430 427">Open the printer left cover and check for toner on the paper ramp. Clean the paper ramp using a soft, dry, lint-free cloth. Refer to <i>Toner Container Replacement</i> on page 3-3.</p> <p data-bbox="748 454 1066 483">Check the transfer roller.</p> <p data-bbox="748 495 1059 580">Open the printer left cover 1 and check the transfer roller.</p> <p data-bbox="748 591 1059 676">If the transfer roller is dirty with toner, try printing several pages.</p> <div data-bbox="1086 465 1422 707">  </div> <p data-bbox="1098 725 1262 754">Transfer Roller</p>
<p data-bbox="161 781 464 810">Characters out of position</p> <div data-bbox="164 826 327 1048">  </div>	<p data-bbox="748 781 1082 810">Check the file or program.</p> <p data-bbox="748 822 1426 945">Check whether the problem is being caused by a PRESCRIBE command error. If the problem occurs only with a specific file or program, the most likely cause is an error in a parameter to a command or command syntax.</p>

Indicators and Messages

The tables on the following pages indicate how to respond to problems indicated by the operation panel indicators and messages.

Indicators





Indicator	Condition	Description
 READY	Flashing	An error occurs that you can clear by yourself.
	Lit	The printer is on-line. The printer is ready to print.
	Off	The printer is off-line. The printer stores but does not print received data. Also indicates when printing is automatically stopped due to occurrence of an error.
 DATA	Flashing	Data transfer is taking place.
	Lit	Either data is being processed, or data is being written onto the option memory card or hard disk.
 ATTENTION	Flashing	The printer needs maintenance attention or the printer is warming up (Please wait).
	Lit	A problem or an error occurs that you can clear by yourself. (For example, a paper jam occurs.)
	Off	Operations are normal.







Maintenance Messages

The following table lists maintenance messages that you can deal with by yourself. If **Call service person** appears, turn off the printer, disconnect the power cord, and contact your local dealer.

Message	Corrective Action
Add paper (paper source)	The paper has run out. Supply paper according to the paper source displayed (paper cassette, MP tray, or optional paper feeder). Messages indicating the printer status (Ready, Please wait, Processing, Waiting, FormFeed TimeOut, Paper loading*) are displayed alternately. * These messages will not appear when the number of copies is set to 2 or more.
Add staples 	The stapler unit is not installed correctly in the document finisher. Install it correctly.
Add staples Press GO	No staples are installed in the stapler. Set it in the stapler. If you wish to continue printing without the staple function, press [GO] .
Call service F###	F### represents a controller error (#=0, 1, 2, ...). Call for service. The printer does not operate when this message is displayed.

Message	Corrective Action
Call service ####:0123456	#### represents a mechanical error (#=0, 1, 2, ...). Call for service. The printer does not operate when this message is displayed. The total number of pages printed is also indicated, e.g. 0123456.
Cassette # not loaded	A cassette is not loaded properly in the printer. Properly load the cassette indicated by #. The number (#) of the cassette is from 1 to 4.
Chad box full	The punch unit chad box of the option document finisher is full. Discard the chads.
Check chad box Press GO	The punch unit waste box of the document finisher is full or is not installed correctly. Check if the box is properly installed, and then discard the chads if the box is full. Press [GO] to resume printing.
Clean printer Press GO	Clean the inside of the printer. Refer to <i>Toner Container Replacement on page 3-3</i> . This message will be displayed when replacing the toner container after the message <i>Replace toner Clean printer</i> is displayed. After cleaning the inside of the printer, press [GO] and the printer will be ready for printing.
Close finisher cover	Close the option document finisher cover.
Close front cover	Close the printer front cover.
Close left cover 1(2,3)	Close the printer left cover. If left cover of the option paper feeder is open, 2 or 3 is displayed.
Close mailbox cover	Close the mailbox cover.
Duplex disabled Press GO	Duplex printing cannot be performed due to paper size or type. Press [GO] and the printer will print on one side only.
Error. Power off F###	Turn the power switch off and then back on again. If this message still remains, turn the power switch off, and contact your service representative or authorized service center.
Finisher tray ## paper full	The finisher tray is full. When removing the paper, printing will be resumed. ## indicates the tray number.

Message	Corrective Action
Finisher path error 	The option document finisher is not installed correctly. Install it correctly.
Incorrect slot Please reinstall	The hard disk or the network interface card has been installed in the wrong slot. Turn off the printer and reinstalled in the correct slot.
Install MK	The maintenance kit (MK-710 for LP 3140 and LP 3151) needs to be replaced. Replace the maintenance kit since the total number of printed pages has reached 500,000. Call for service. The maintenance kit includes a drum unit, developer unit and so on.
Folding tray paper full	The folding tray has become full. You must remove all printed pages from the folding tray. When the printer senses that the folding tray is empty again, it will continue printing into the folding tray.
Load cassette # (paper size)/(paper type)* *(paper size) and (paper type) are displayed flashing alternately. 	There is data for printing that matches with a paper cassette setting (paper size, paper type), but there is no paper in the paper cassette. Set paper into the paper source as indicated by # in the operation panel, and press [GO] to restart printing. However, the paper source numbers (3 to 4) are only displayed when there is an option paper feeder installed. Or, if you want to print from a different paper source press Δ or ∇ to display Use alternative? (paper size)/(paper type) * and you can change the source for paper feeding. After selecting a paper source and pressing [MENU] , Paper Handling > appears. By pressing \triangleright , the paper size and type settings menu appears. After setting the correct paper size and type, press [OK] to check the paper source, and press [GO] to start printing.
Load MP tray (paper size)/(paper type) *(paper size) and (paper type) are displayed flashing alternately. 	There is no paper cassette set (paper size, paper type) that matches with the data for printing, so printing is done from the MP tray. Set paper into the MP tray that matches the paper size and type shown on the display and press [GO] to restart printing. Or, if you want to print from a different paper source press Δ or ∇ to display Use alternative? (paper size)/(paper type) * and you can change the source for paper feeding. After selecting a paper source and pressing [MENU] , Paper Handling > appears. By pressing Δ , the paper size and type settings menu appears. After setting the correct paper size and type, press [OK] to check the paper source, and press [GO] to start printing.
Mailbox tray ## paper full 	The mailbox tray is full. When removing the paper, printing will be resumed. ## indicates the tray number.



Message	Corrective Action
Missing chad box	The punch unit chad box of the document finisher is not installed correctly. Install it correctly.
Missing folding tray	The folding tray is not installed correctly. Install it correctly.
Missing folding unit	The folding unit is not installed correctly. Install it correctly.
Missing toner container 	Install the toner container. Refer to <i>Toner Container Replacement on page 3-3</i> . The printer does not operate when this message is displayed.
Missing waste toner box 	Install the waste toner box. Refer to <i>Toner Container Replacement on page 3-3</i> . The printer does not operate when this message is displayed.
No multi copies Press GO	Multiple copies cannot be printed because RAM disk is disabled or the hard disk is not installed. There is no available RAM disk or hard disk space. Delete unnecessary files. Press [GO] to print error report.
Paper jam ##### 	Open the front cover or left cover and correct the paper jam (or paper mis-feeding in the paper cassette). The location of the paper jam is also indicated in place of the #'s. Online help messages which are useful for correcting the paper jam will be displayed by pressing the  key. (Refer to <i>Correcting a Paper Jam on page 4-14</i> .)
Replace toner Clean printer 	Replace the toner container using a new toner kit. The printer does not operate when this message is displayed. Refer to <i>Toner Container Replacement on page 3-3</i> .
Replace waste toner box	Replace the old waste toner box with the new one which is included in the toner kit. The message will also be shown if the waste toner box has become full. The waste toner box should be replaced when the message display eventually shows <i>Toner low</i> . Refer to <i>Toner Container Replacement on page 3-3</i> .
Set paper Press GO	There is no paper in the MP tray when printing from the MP tray. Set paper into the MP tray, and press [GO] to restart printing.
Toner low	Replace the toner container using a new toner kit. Refer to <i>Toner Container Replacement on page 3-3</i> .
Top tray paper full 	The top tray has become full (approx. 500 pages). You must remove all printed pages from the top tray. When the printer senses that the top tray is empty again, it will continue printing into the top tray.

Message	Corrective Action
Warning image adapt	Printing job cannot be done in current resolution because there is not enough internal memory. Try adding more memory or changing resolution.
Warning low memory	The printer's internal memory is running low due to the number of fonts and macros downloaded. Print a status page to see how much user memory is left, and try deleting unnecessary fonts and macros.



 :Alarm buzzer sounds when an error occurs. Press [CANCEL] to stop the alarm buzzer.

Error Messages

The following table lists error messages that can be dealt with by the user.

Message	Corrective Action
File not found Press GO	VMB: A VMB tray that was specified for output does not contain any jobs, or the VMB tray is not being used. Confirm the VMB tray.  If Auto Continue is set to On, printing will be automatically resumed after a preset period of time.
Format error Memory card	This message appears when the printer is in the ready state and the memory card is not formatted, and therefore cannot be read or written.
Format error Hard disk	Initialization (formatting) of the hard disk is required. Initialize the hard disk.
Hard disk err ## Press GO	Look at the error code given in place of ## and refer to the corresponding description given below. 01: Hard disk format error. If this error recurs even if the power has been turned off and then on, reformat the hard disk. 02: The disk system is not installed. Recheck the requirements for using the system and the devices. 04: There is no available hard disk space. Delete unnecessary files, etc., to free up space. 05: The specified file does not exist in the hard disk. 06: There is no memory available to the hard disk system. Increase the available memory. 10: Formatting is not possible because host data is being spooled on the hard disk. Wait until Ready is displayed, and then format. 20: The hard disk was installed in the incorrect slot (OPT). Reinstall the hard disk in a different slot (HDD). 85: VMB; Alias error (the alias setting was lost, or the VMB tray corresponding to the alias does not exist). Set the alias again. 97: Code job; The number of permanent code jobs reached the limit value, and no more can be saved. Either delete some unnecessary jobs, etc., or increase the limit.  99: A print job for the specified ID does not exist in the hard disk.
I/F occupied	This message is displayed when you attempt to use the printer's operation panel to change the environmental settings on the interface from which data are presently being received.

Message	Corrective Action
ID error	The ID entered for a private job, or a stored job is not correct. Check the ID that is set using the printer driver.
Insert the same Memory card	You have inserted the wrong memory card when the <code>Insert again</code> message was displayed. Remove the wrong memory card from the printer's memory card slot and insert the correct memory card. The printer again reads it from the beginning of the data.
KPDL error ## Press GO	Current print processing cannot continue. To print out an error report, display <code>>Print KPDL Errs</code> from the mode select menu, and select <code>On</code> . Press [GO] to resume printing. You can abandon printing by [CANCEL] . If Auto Continue is set to <code>On</code> , printing will be automatically resumed after a preset period of time.
Memory card err Insert again	The memory card is accidentally removed from the printer's memory card slot during reading. If you continue reading the memory card, insert the same memory card into the slot again. The printer again reads it from the beginning of the data. <hr/> NOTE: We recommend that you follow the reading procedure from the beginning to ensure correct reading of the memory card.
Memory overflow Press GO	The total amount of data received by the printer exceeds the printer's internal memory. Try adding more memory (expansion DIMM). Press [GO] to resume printing. You can abandon printing by [CANCEL] . If Auto Continue is set to <code>On</code> , printing will be automatically resumed after a preset period of time.
MemoryCard err## Press GO	This message appears when an error occurs during access to the memory card using the <code>PRESCRIBE RWER</code> command or from the printer's operation panel. Look at the error code given in place of ## and refer to the corresponding description given below. 01: The memory card does not meet specifications. This memory card cannot be used by this printer. Insert a memory card which can be used by this printer. 02: The memory card is not installed. Recheck the requirements for using the memory card. 04: The capacity of the memory card is insufficient. Clean up files. 05: Specified file is not on the CompactFlash card. 06: No memory for use by memory card. Expand printer memory.
Print overrun Press GO	The data transferred to the printer was too complex to print on a page. Press [GO] to resume printing. (The page may break in some pages.) You can abandon printing by [CANCEL] . <hr/> NOTE: After this message is displayed, page protect mode will be <code>On</code> . To maintain optimum use of memory during printing, display <code>>Page Protect</code> from the operation panel, and re-select <code>Auto</code> . If Auto Continue is set to <code>On</code> , printing will be automatically resumed after a preset period of time.

Message	Corrective Action
RAM disk error ## Press GO 	Look at the error code given in place of ## and refer to the corresponding description given below. 01: Format error. Try turning the power off and on again. 02: RAM disk mode is Off. Turn RAM disk mode On. 04: No disk space. Clean up files. 05: Specified file is not on disk. 06: No memory for use by disk system. Expand printer memory.
Virtual mailbox full	The storage area for the VMB is full. Print out accumulated VMB data.
USB mem. removed Press GO 	The USB flash memory is accidentally removed from the printer. To ignore the USB memory error, press [GO] . The message display returns to Ready.
USB memory err05 Press GO	The designated file does not exist. Check the designated file name and existence of the file in the USB memory.
Unknown toner installed	The installed toner container is displayed if determined not to be an original toner container by the self-diagnostic performed after power is switched on. If this message is displayed, the amount of toner remaining cannot be checked.

 :Alarm buzzer sounds when an error occurs. Press **[CANCEL]** to stop the alarm buzzer.

Correcting a Paper Jam

The Paper jam message is displayed on the message display when paper becomes stuck in the paper transport system, the paper feed timing is incorrect, or paper fails to feed at all. The jam can be corrected by removing the paper.

The printer goes off-line when the Paper jam message is displayed.

When a paper jam occurs, a paper jam message and the paper jam location are indicated on the message display. Details of the messages and paper jam locations are as follows:

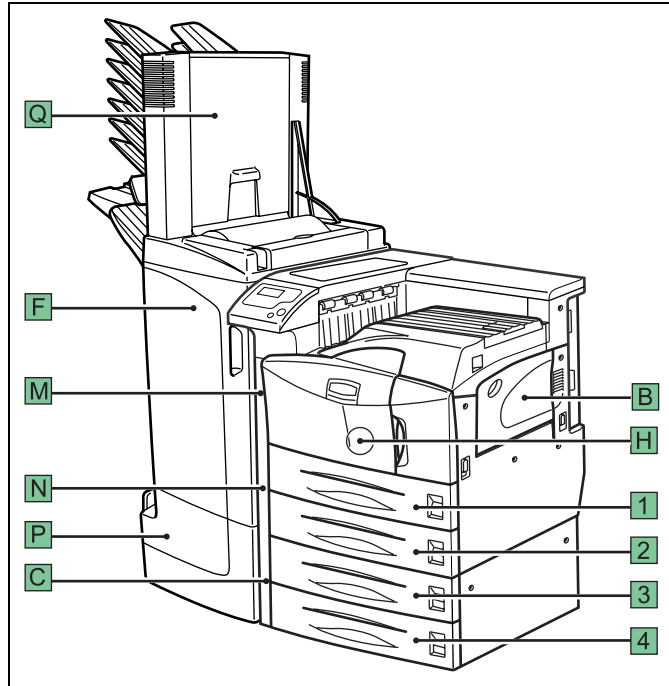

Paper jam message	Paper jam location	Description	Reference page
Paper jam Cassette 1	1	Paper is jammed at the upper cassette or inside the printer.	4-16
Paper jam Cassette 2	2	Paper is jammed at the lower cassette or inside the printer.	4-16
Paper jam Cassette 3	3	Paper is jammed at an option paper feeder cassette. (PF-700 upper cassette, PF-750)	4-16
Paper jam Cassette 4	4	Paper is jammed at an option paper feeder cassette. (PF-700 lower cassette)	4-16
Paper jam Finisher	F	Paper is jammed in the paper stacker of the option finisher (F).	DF-710 or DF-730 Operation Guide
Paper jam Folding Unit	P	Paper is jammed in the booklet folder (P).	DF-710 Operation Guide

Paper jam message	Paper jam location	Description	Reference page
Paper jam Cassette	1, 2, 3, 4	Paper is jammed in the paper cassette.	4-16
Paper jam MP Tray	B	Paper is jammed at the multi purpose (MP) tray.	4-17
Paper jam MP Transport	H	Paper is jammed at the MP transport.	4-17
Paper jam Left Cover 1	M	Paper is jammed in a left cover section.	4-21
Paper jam Left Cover 2	N	Paper is jammed in a left cover section.	4-22
Paper jam Left Cover 3	C	Paper is jammed in the left cover section of an option unit. (PF-700, PF-750)	4-23
Paper jam Mailbox	Q	Paper is jammed at the mailbox.	DF-710 Operation Guide

When the jammed paper has been removed, open and close the printer's front cover. Then the printer automatically warms up, goes on-line, and continues printing. Depending on the point at which the jam occurred, the printer may or may not print the jammed page.

If paper jams occur frequently, try using a different type of paper, replace with paper from another ream, turn the stack of paper over, or turn the paper the other way around. Also, look for tiny pieces of paper that may have been torn off and overlooked when the jammed paper was removed.

If you cannot solve the problem by changing the paper, there may be a problem with the printer. Contact your service representative.

NOTE: When removing jammed paper, pull it out carefully so as not to tear it. Torn pieces of paper are difficult to remove and may be hard to find. Be sure to remove them all.

Online help messages

With the online help message function, this printer can display the procedure to correct a paper jam on the message display. When a paper jam message is displayed, press the **?** key.

Pressing **▽** at the online help message display shows the next step; pressing **△** shows the previous step. To exit the online help message display, press the **?** key. The previously shown paper jam message appears.

Paper Cassette

The following procedure also applies to the optional paper feeder.

- 1 Pull out the paper cassette.

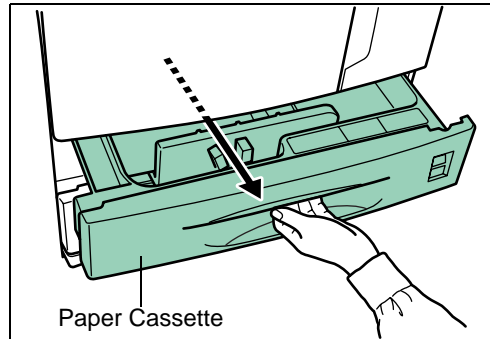

- 2 Remove the jammed paper while taking care not to tear it. If the paper has been torn, remove all the scraps from the inside the printer.

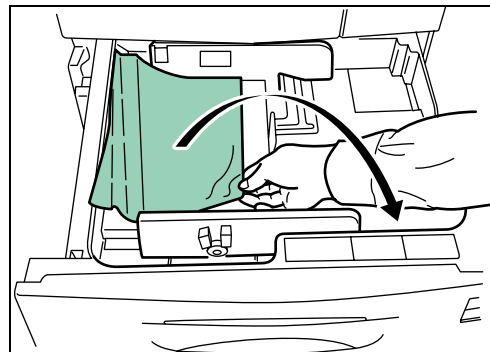

- 3 Close the paper cassette.

MP Tray

Paper is jammed at the MP tray. Remove the jammed paper using the procedure given below.

- 1 Remove the paper jammed at the MP tray.

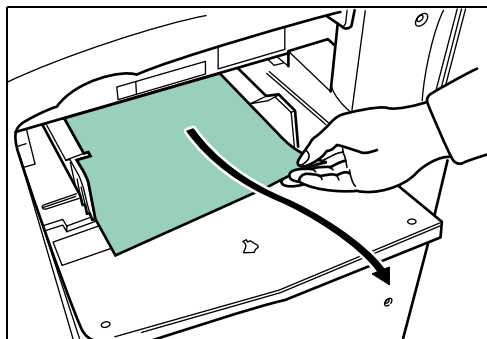

- 2 If the jammed paper remains at the MP tray, pull up the lever and remove the jammed paper.

If the missed paper cannot be removed, go to the next step.

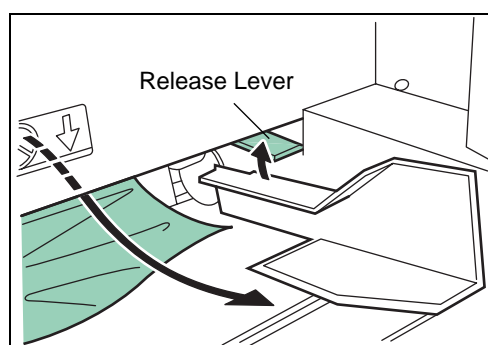

Inside the MP transport

- 1 Pull up the lock lever and open left cover 1.

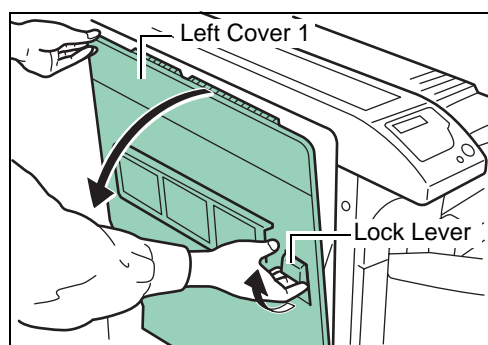

- 2** Remove the jammed paper.

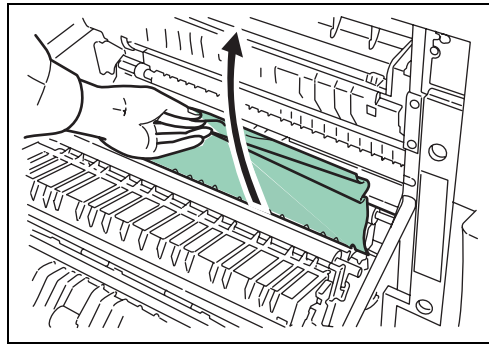

- 3** Push the lever (gray colored) to raise the duplex unit and remove the jammed paper.

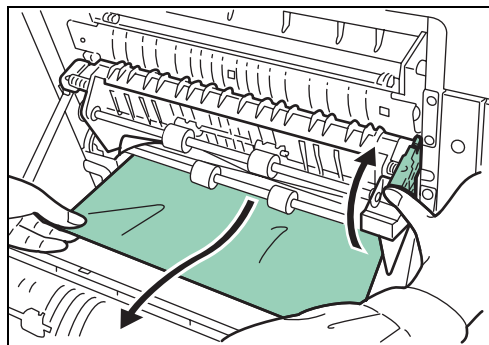

- 4** Open the front cover.

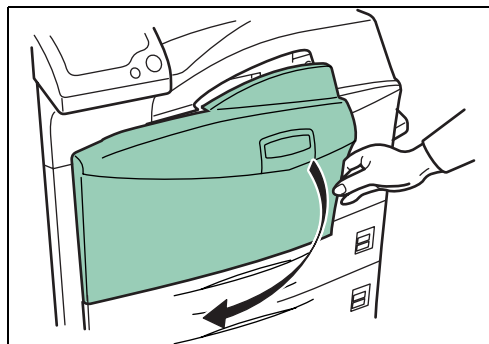

- 5 Turn the knob clockwise to release the jammed paper from the MP transport tray section.

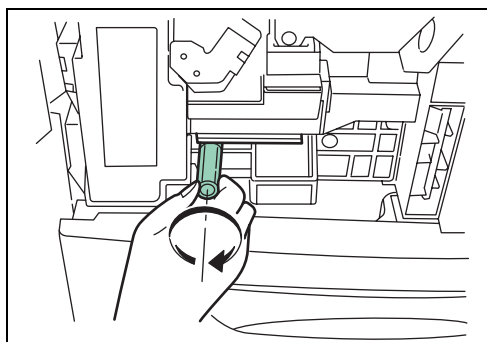

- 6 Open left cover 1 to remove paper jammed in the MP transport tray.

NOTE: When removing jammed paper, be careful not to touch the printer drum. This can cause printer malfunction.

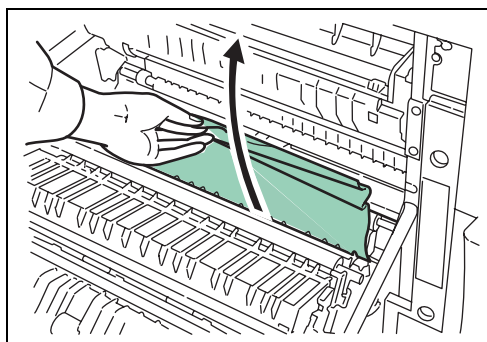

- 7 Pull out the MP transport tray as far as it will go.

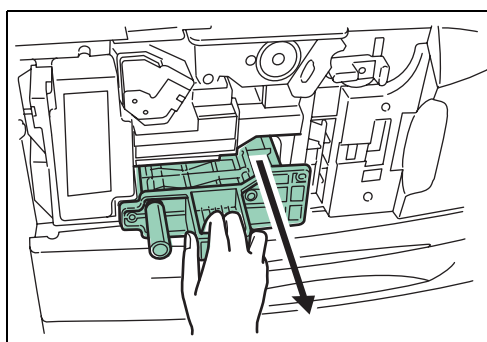

- 8** Open the MP transport tray cover and remove any jammed paper.

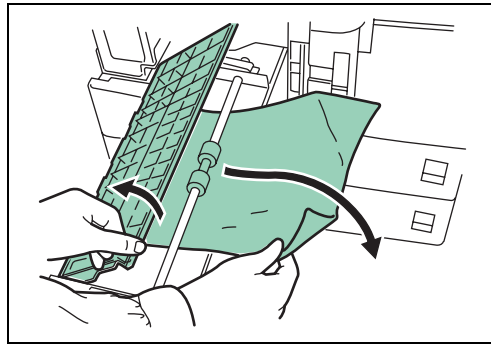

- 9** If the paper has been torn, remove the jammed paper.

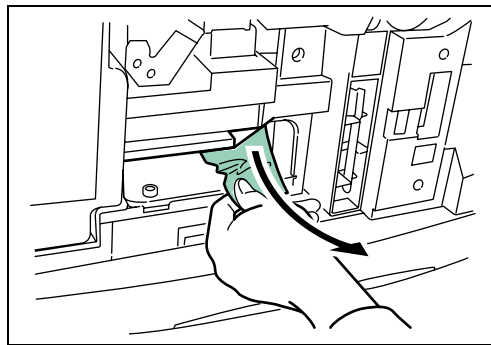

- 10** Replace the MP transport tray in its original position, then close the front cover.

Jam in Left Cover 1



WARNING: The printer's fixing unit is extremely hot. Take sufficient care when working in this area, as there is a danger of getting burned.



CAUTION: Take care not to leave any small pieces of paper in the printer when removing paper jams as this may result in fire.

- 1 Pull up the lock lever and open left cover 1.

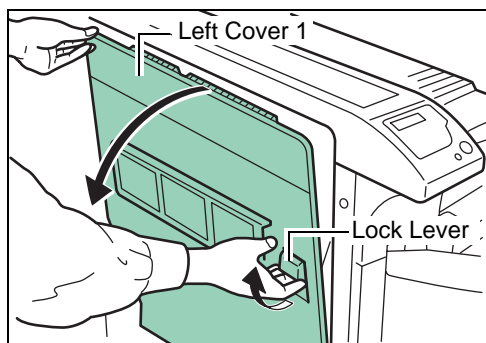

- 2 Remove the jammed paper.

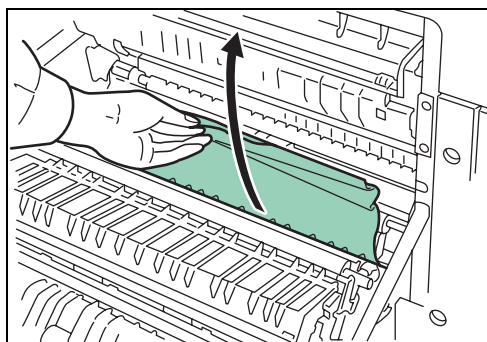

- 3 Push the lever (gray colored) to raise the duplex unit and remove the jammed paper.

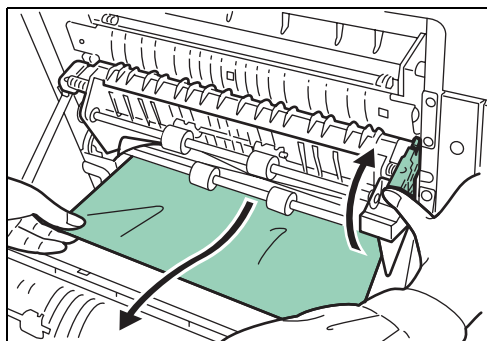

- 4** If there is jammed paper in the output section, remove it.

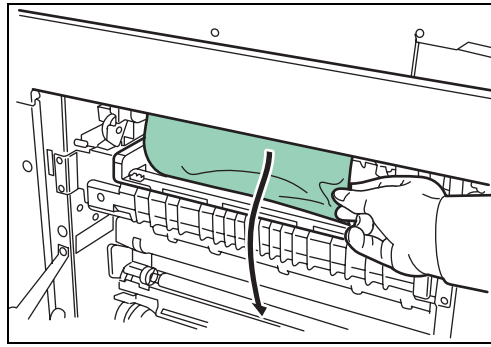

- 5** Close left cover 1.

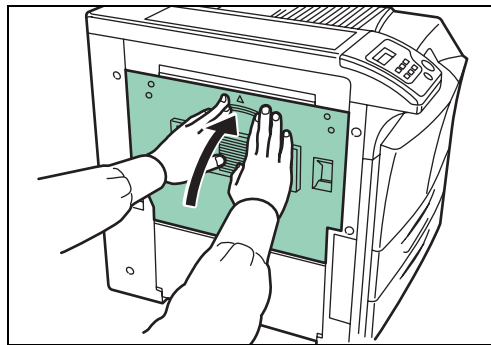

Left Cover 2

- 1** Open left cover 2.

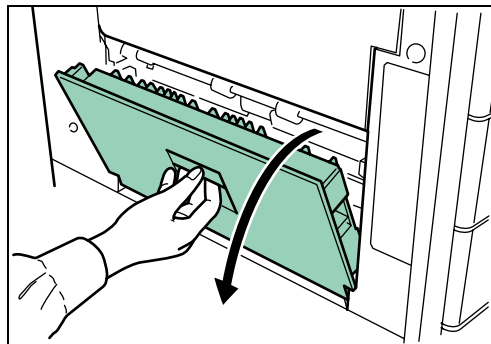

- 2 Remove the jammed paper.

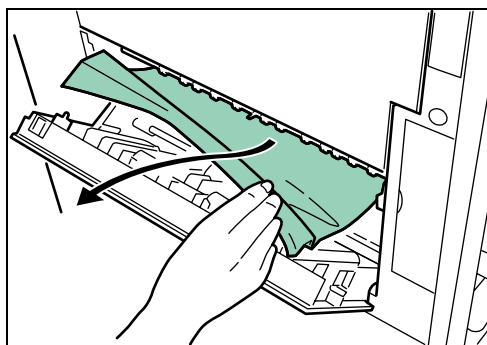

- 3 Close left cover 2.

Document Finisher

Paper is jammed at the option document finisher. Remove jammed paper referring to the *DF-710 Operation Guide* or *DF-730 Operation Guide*.

5 Specifications

NOTE: Specifications are subject to change without notice.

Item	Description	
	LP 3140	LP 3151
Printing method	Electrophotography, laser scan	
Printing speed	A4/Letter : 40 pages/minutes A3 : 23 pages/minutes B4 : 27 pages/minutes	A4/Letter : 51 pages/minutes A3 : 26 pages/minutes B4 : 31 pages/minutes
Duplex speed	A3 : 16 pages/minutes A4 : 33 pages/minutes Letter : 33 pages/minutes	A3 : 17 pages/minutes A4 : 37 pages/minutes Letter : 37 pages/minutes
Resolution	Fast 1200 mode 600 dpi with KIR (Kyocera Image Refinement) 300 dpi with KIR (Kyocera Image Refinement)	
First print (A4 or Letter size, depending on input data. From start of feed to end of output.)	Approx. 3.5 seconds or less (During printing) Approx. 60 seconds (During sleep mode)	Approx. 3.5 seconds or less (During printing) Approx. 60 seconds (During sleep mode)
Warm-up time (23°C, 120 or 230 V) -Power on -Low power -Sleep	60 seconds or less 30 seconds or less 60 seconds or less	60 seconds or less 30 seconds or less 60 seconds or less
Controller	PowerPC 750 FL (600 MHz)	PowerPC 750 FL (600 MHz)
Main memory	64 MB, expandable up to 576 MB	128 MB, expandable up to 640 MB
Operating Systems	Microsoft Windows 95/98/Me/2000/XP Microsoft Windows NT4.0 Microsoft Windows Server 2003 Apple Macintosh OS 9 Apple Macintosh OS X	
Interface -Standard -Option	Parallel: IEEE1284 USB: Hi-Speed USB USB Host interface (USB 1.1) for USB Flash memory supports PDF Direct Printing Network: 10BASE-T/100BASE-TX Option: Network interface card (UT-110) or serial interface card and hard disk (KUIO-LV)	

Item	Description	
	LP 3140	LP 3151
Memory card slot	1: Memory card (CF)	
Self test	Performed at power-up	
Maximum duty cycle	200,000 pages/month	300,000 pages/month
Drum	Amorphous silicon drum	
Paper sizes -Cassette	A3, A4, A5, B4, B5, Ledger, Letter, Legal, Folio, Oficio II, and Statement	
-MP Tray	A3, A4, A5, A6, B4, B5, B6, Ledger, Letter, Legal, Envelope Monarch, Envelope DL, Envelope C4, Envelope C5, ISO B5, Executive, Envelope # 6, Envelope # 9, Envelope # 10, Hagaki, Oufuku Hagaki, Oficio II, 8 kai, 16 kai-R, Statement, Folio, Yokei 2, Yokei 4, and Custom	
Media types -Cassette	Plain, Preprinted, Bond, Recycled, Rough, Letterhead, Color, Prepunched, Vellum, High quality, and Custom	
-MP Tray	Plain, Transparency, Preprinted, Labels, Bond, Recycled, Vellum, Rough, Letterhead, Color, Prepunched, Envelope, Cardstock, Thick, High quality, and Custom	
Media weights -Cassette	64g/m ² to 105g/m ²	
-MP Tray	64g/m ² to 170g/m ²	
-Duplex mode	64g/m ² to 105g/m ²	
Capacity of output tray	500 sheets of thickness 0.11 mm	
Ambient conditions	Temperature : 10 to 32.5 °C (50 to 90.5 °F) Humidity : 15 to 80 % RH Optimum conditions : 23 °C (73.4 °F), 60 % RH Altitude : Max. 2,500 m (6500 feet) Illumination : Max. 1,500 lux	
Power requirements	120 V, 60 Hz, max. 11.4 A (U.S.A./ Canada) 220-240 V, 50 Hz/60 Hz, max. 6.1 A (European countries) Max. allowable voltage fluctuation: ±10 % Max. allowable frequency fluctuation: ±2 %	120 V, 60 Hz, max. 11.4 A (U.S.A./ Canada) 220-240 V, 50 Hz/60 Hz, max. 6.1 A (European countries) Max. allowable voltage fluctuation: ±10 % Max. allowable frequency fluctuation: ±2 %
Operating noise (in accordance with EN ISO 7779 [Bystander Position, sound pressure level at the front, and simplex printing])	During printing: LpA=72 dB(A) During standby: LpA=52 dB(A) During sleep mode: Immeasurably low	During printing: LpA=72 dB During standby: LpA=52 dB During sleep mode: Immeasurably low
Dimensions (W x D x H)	599 x 646 x 615 mm (23-5/8 x 25-1/8 x 24-1/2")	
Weight	68 kg (150 lb), main unit only	

